



UPSALA PRAWA

WANNA
NAROŻNA

→ ← 5,5 CM
GRUBOŚCI RANTU

AKRYLOWA WANNA NAROŻNA

KOD: AWW-009-170ZP-P

WYMIARY: 1700 x 750 x 580 mm

WAGA: 35 kg

POJEMNOŚĆ: 280l

PRZELEW: szczelinowy typu cut-in

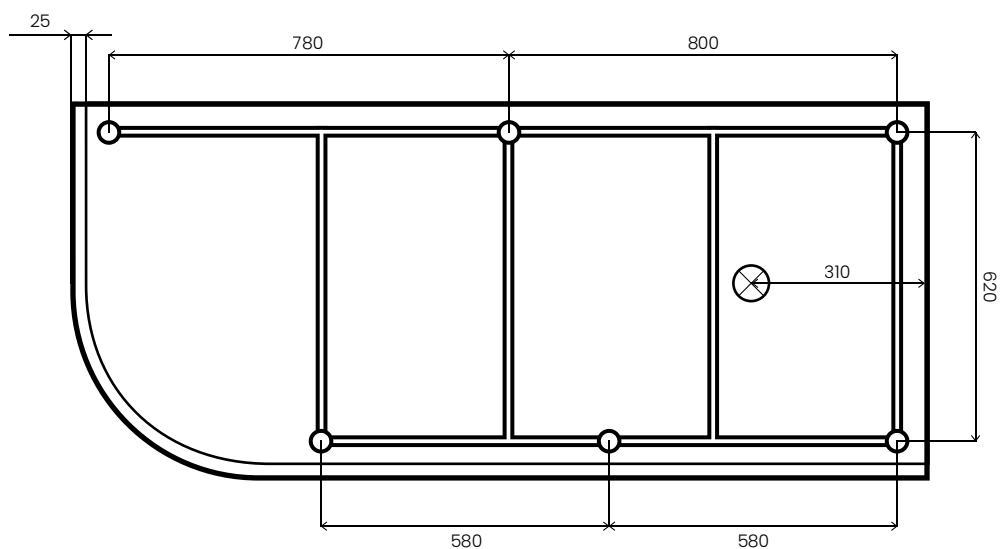
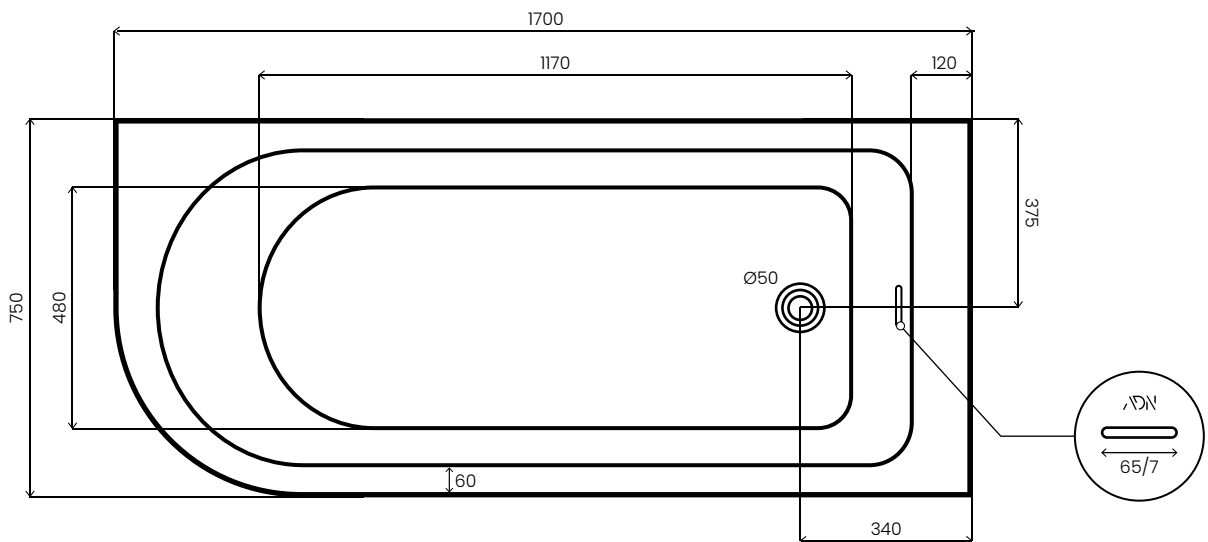
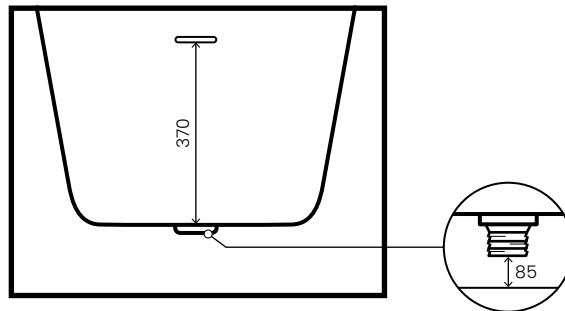

Wszystkie wymiary podano w milimetrach (mm).